



# CELOSIA SYMBOL

cevica®  
the tile atelier



# CELOSIA SYMBOL

La celosía SYMBOL nace bajo la premisa de controlar en la medida de lo posible ese paso de luz, jugando con la densidad de huecos que ofrece la celosía en su composición. En sus versiones, con el formato de celosía cuadrada de 15×15 cm existente, consigue componer paños de celosía capaces de aumentar y disminuir los huecos de entrada de luz según las necesidades del interior.

The SYMBOL lattice was born under the premise of controlling this passage of light as much as possible, playing with the density of holes that the lattice offers in its composition. In its versions, with the existing 15x15 cm square lattice format, it manages to compose lattice panels capable of increasing and decreasing the light entry gaps according to the needs of the interior.



## Formatos. Formats

---



CELOSIA SYMBOL "T"  
LB18



CELOSIA SYMBOL "D"  
LB18



CELOSIA SYMBOL "V"  
LB18



CELOSIA SYMBOL "X"  
LB18

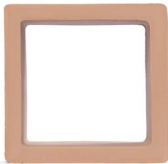

CELOSIA SYMBOL SQUARE  
LB35

4 /

La medida de la celosia puede sufrir una variación de 2-4 mm. Por ese motivo se recomienda no realizar ningún montaje previo para insertar las celosias hasta recibir las en obra | Puede que haya ligeras variaciones entre piezas del mismo color | Las piezas pueden presentar imperfecciones propias de los productos artesanales, pero esto no altera la calidad de la pieza y en ningún caso serán motivo de reclamación (ver fotos página 26).

The measure of the lattice can undergo a variation of 2-4 mm. For this reason, it is recommended not to carry out any previous assembly to insert the lattices until they are received on site | There may be slight variations among pieces of the same colors | The pieces may have imperfections typical of handcrafted products, but this does not alter the quality of the piece and in no case will be cause for complaint (see photos page 26).

CELOSIA SYMBOL

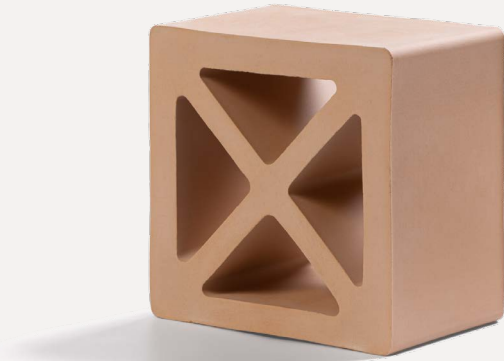
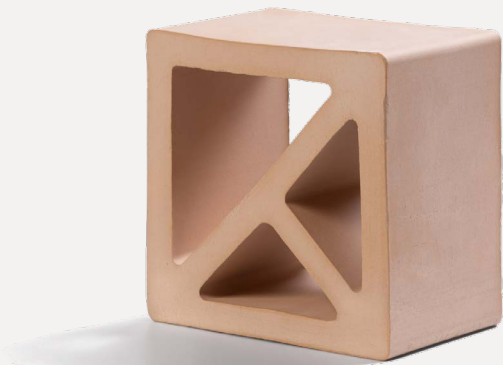

## Dimensiones. Dimensions

### CELOSIA SYMBOL "T"

Medida nominal | Nominal size: 15x15x10 cm | 6"x6"x4"  
 Peso | Weight: 2,33 kg | 5.13 lb

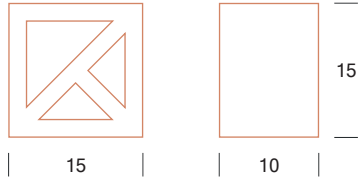

### CELOSIA SYMBOL "D"

Medida nominal | Nominal size: 15x15x10 cm | 6"x6"x4"  
 Peso | Weight: 2,43 kg | 5.35 lb

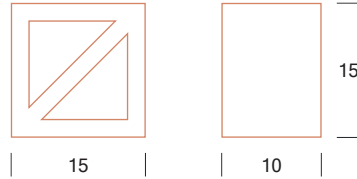

### CELOSIA SYMBOL "V"

Medida nominal | Nominal size: 15x15x10 cm | 6"x6"x4"  
 Peso | Weight: 2,43 kg | 5.35 lb

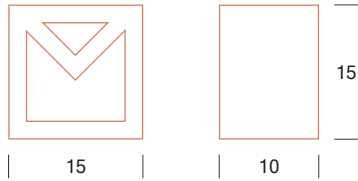

### CELOSIA SYMBOL "X"

Medida nominal | Nominal size: 15x15x10 cm | 6"x6"x4"  
 Peso | Weight: 2,83 kg | 6.23 lb

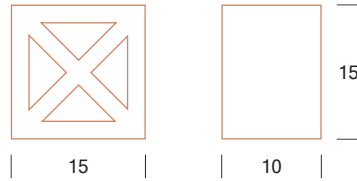

### CELOSIA SYMBOL SQUARE

Medida nominal | Nominal size: 15x15x10 cm | 6"x6"x4"  
 Peso | Weight: 2,23 kg | 4.91 lb

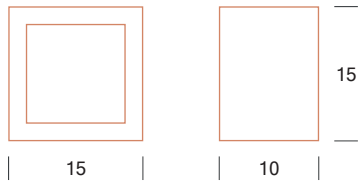

6 /

Embalaje. Packing		KG / P	P / PALLET	KG / PALLET	M <sup>2</sup> / PALLET
Celosia Symbol "D"	15x15x10   6"x6"	2,33	350	837,5	7,78
Celosia Symbol "T"	15x15x10   6"x6"	2,43	350	872,5	7,78
Celosia Symbol "V"	15x15x10   6"x6"	2,43	350	872,5	7,78
Celosia Symbol "X"	15x15x10   6"x6"	2,83	350	1.012,5	7,78
Celosia Symbol square	15x15x10   6"x6"	2,23	350	802,5	7,78

1 m<sup>2</sup> Celosia Symbol = 45 p.

CELOSIA SYMBOL

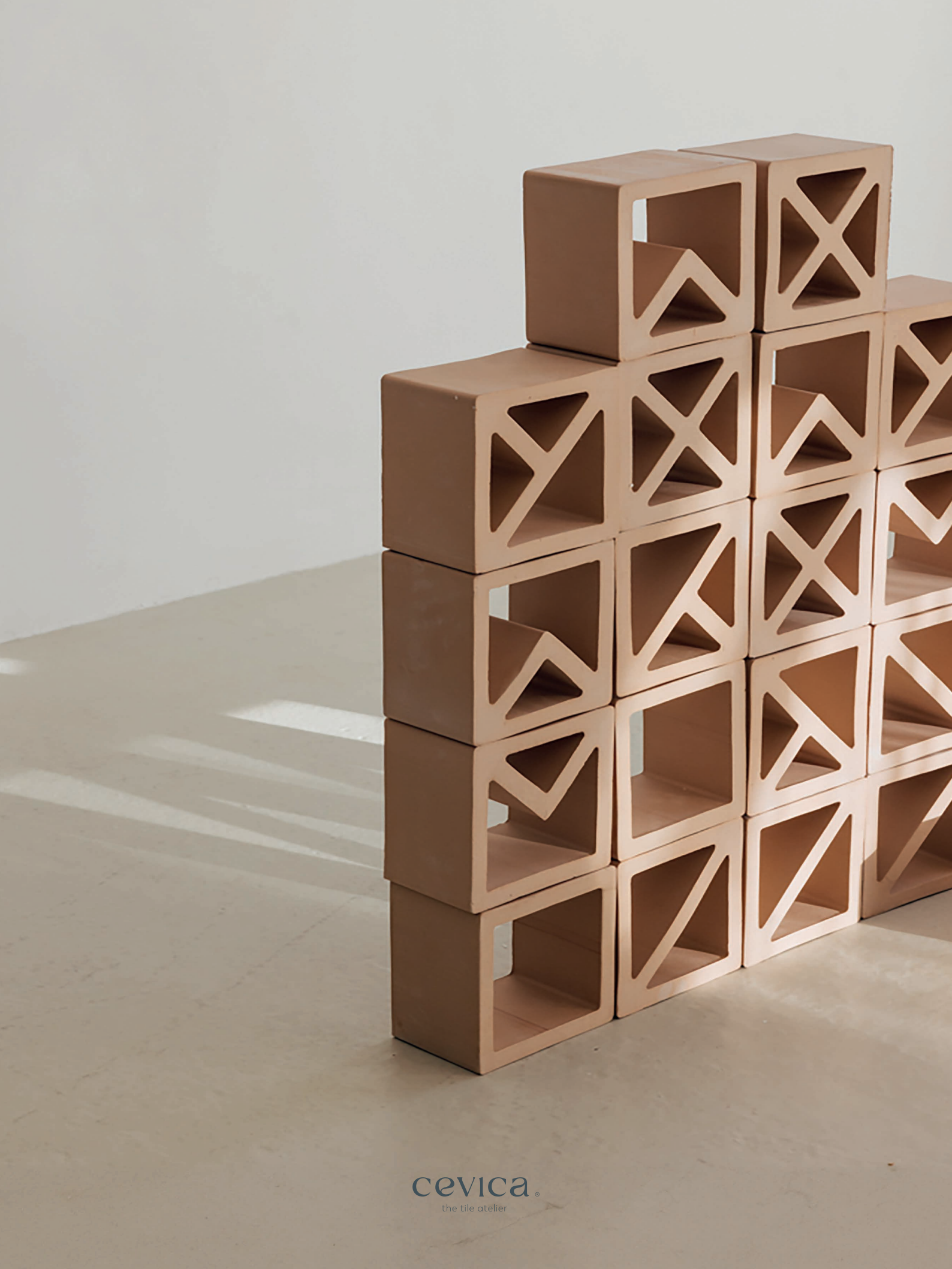

CELOSIA SYMBOL "T"

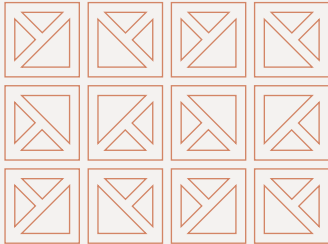

8 /

PAVIMENTO | FLOOR TILE  
Kromatic Cream 31x31 | LB68





CELOSIA SYMBOL "V"

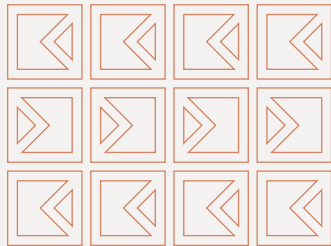

REVESTIMIENTO | WALL TILE  
Antic Laurel 13x13 cm | CEM09  
Antic Laurel 7,5x15 cm | CEM09

PAVIMENTO | FLOOR TILE  
Karma Green Matte 14x16 cm | LB42





CELOSIA SYMBOL "X" / CELOSIA SYMBOL "D"

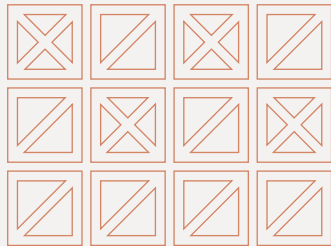

12 /

REVESTIMIENTO | WALL TILE  
Terre Caramel 5x15 cm | LB66

PAVIMENTO | FLOOR TILE  
Kromatic Cotto 31x31 cm | LB68



# CVK

restaurant



CELOSIA SYMBOL SQUARE / CELOSIA SYMBOL "D"

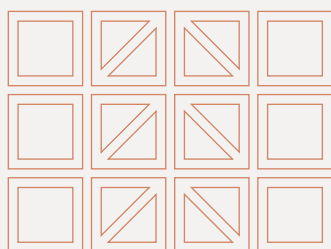

14 /





CELOSIA SYMBOL "X"

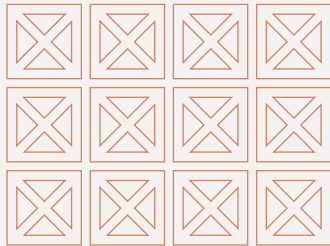

REVESTIMIENTO | WALL TILE  
Zelij Miel 5x20 cm | CEM17

PAVIMENTO | FLOOR TILE  
Karma Cotto Matte 14x16 cm | LB42





# Composiciones. Compositions

---

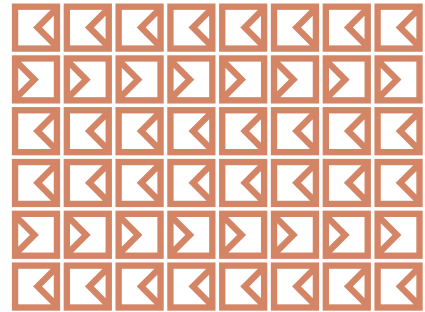
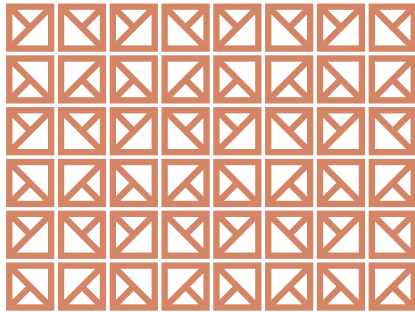

18 /

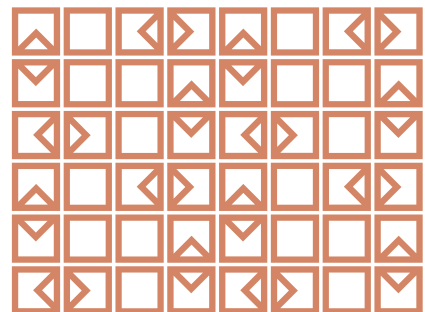
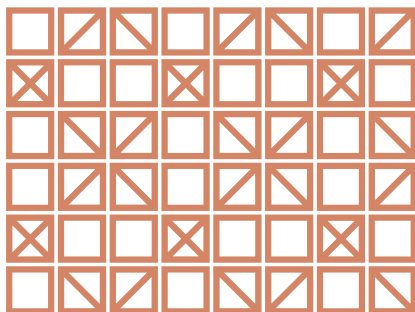
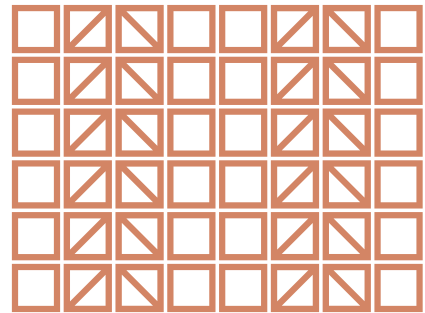
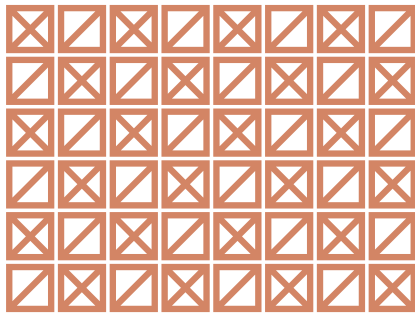

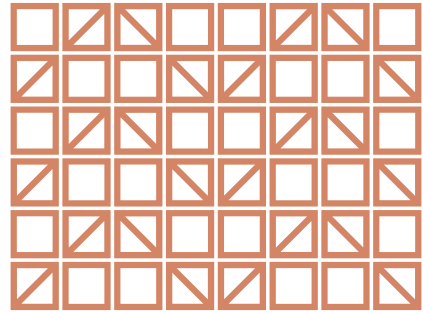
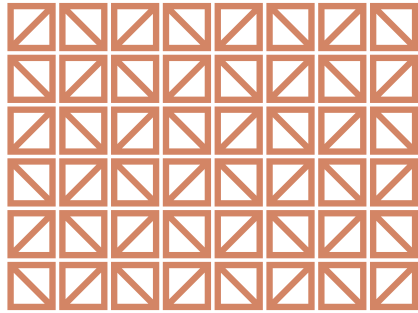
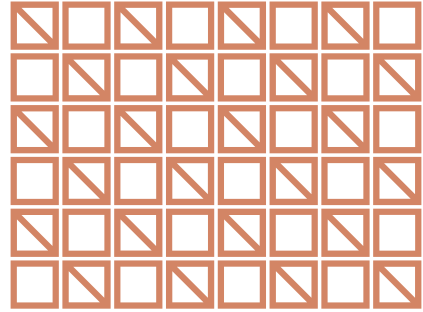
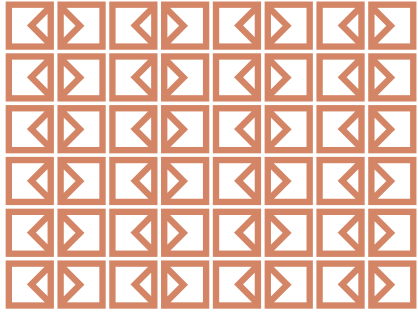

/ 19

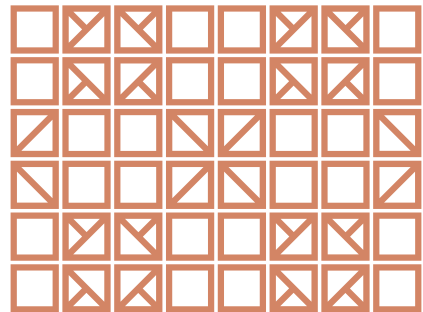
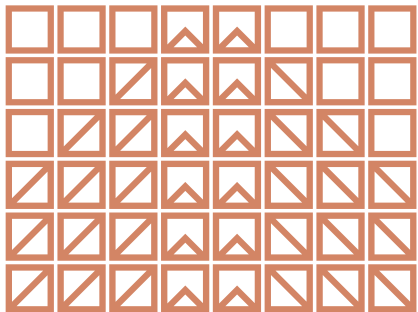

## Consejos de colocación. Placements advices

---

ESP

### Recomendaciones generales

El coeficiente de dilatación térmica de las celosías cerámicas es  $6 \times 10^{-6}/10\text{ C}$  y debe tenerse en cuenta en relación con el coeficiente de dilatación térmica del material de soporte (por ejemplo, el coeficiente de dilatación térmica del hormigón es  $12 \times 10^{-6}/10\text{ C}$ ).

### Colocación

Recomendamos replantear la colocación de las celosías a partir de un módulo de dimensiones máximas de 325x325 cm.

Entre módulos de celosías es recomendable establecer una junta de dilatación.

Es recomendable que el paño de celosías este abrazado perimetralmente para dar más estabilidad al conjunto.

La unión entre las celosías se puede hacer con mortero de cemento portland y arena fina cribada de dosificación 1:3 o bien utilizando resinas adhesivas de poliuretano tipo "Sikaflex".

La elección de la unión dependerá de la estabilidad dimensional de la celosía, si lleva o no rehundidos laterales para embeber la armadura (los modelos CELOSIA SYMBOL, no presenta rehundidos), el lugar de colocación interior o exterior y del acabado estético del paño de celosías.

Si optamos por el mortero de cemento, podemos dejar las juntas rehundidas o enrasadas según cada criterio (el rehundido refuerza mas las sombras entre piezas y el enrasado acentúa el efecto de "plano perforado" del conjunto de celosías).

Para la aplicación de las celosías en fachada, lo recomendable es la utilización de anclajes tipo MURFOR, tanto en verticales cómo en horizontales.

Cada obra es un mundo, pero por norma general, recomendamos colocar MURFOR cada tres hiladas verticales y al tresbolillo en horizontal.

Para la aplicación de celosías en interiores, podemos utilizar varilla roscada de acero inoxidable de 6 mm de diámetro, colocando dos varillas en la horizontal al tresbolillo y una en la vertical cada tres hiladas.

La armadura quedará embebida en el mortero de cemento y si utilizamos silicona es necesario que la celosía lleve hendidura perimetral.

Para cada caso, será imprescindible el asesoramiento estructural de un especialista.

## General recommendations

The thermal expansion coefficient of ceramic lattices is  $6 \times 10^{-6}/10^\circ\text{C}$  and must be taken into account in relation to the thermal expansion coefficient of the supporting material (for example, the thermal expansion coefficient of concrete is  $12 \times 10^{-6}/10^\circ\text{C}$ ).

## Placement

We recommend reconsidering the placement of the lattices starting from a module with a maximum size of  $325 \times 325$  cm.

It is advisable to establish an expansion joint between lattice modules.

It is recommended that the latticework cloth be hugged around the perimeter to give more stability to the whole.

The connection between the lattices can be made with Portland cement mortar and fine screened sand in a 1:3 dosage or using "Sikaflex" type polyurethane adhesive resins.

The choice of joint will depend on the dimensional stability of the lattice, whether or not it has side recesses to embed the reinforcement (CELOSIA SYMBOL models do not have recesses), the interior or exterior placement location and the aesthetic finish of the lattice panel. . If we opt for cement

mortar, we can leave the joints recessed or flush according to each criterion (the recess reinforces the shadows between pieces more and the flush accentuates the "perforated plane" effect of the set of lattices).

For the application of lattices on the façade, it is recommended to use MURFOR type anchors, both vertically and horizontally.

Each work is different, but as a general rule, we recommend placing MURFOR every three vertical rows and staggered horizontally.

For the application of lattices indoors, we can use 6 mm diameter stainless steel threaded rod, placing two rods horizontally in a staggered manner and one vertically every three courses.

The reinforcement will be embedded in the cement mortar and if we use silicone it is necessary that the lattice has a perimeter slit.

For each case, the structural advice of a specialist will be essential.

## Consejos de colocación. Placements advices

- **Paramento vertical de celosía apoyado en forjado inferior.**  
Vertical lattice facing supported on lower slab.

Remate metálico 10 mm espesor.  
Metal trim 10 mm thickness.

Junta de mortero de cemento  
10-15 mm espesor.  
10-15 mm thick cement mortar joint.

Anclaje tipo Murfor MurAnc S  
80C cada 60 cm.  
Murfor MurAnc S 80C type anchor  
every 60 cm.

Armadura triangulada de refuerzo  
Murfor RND.5/S, anchura 50 mm.  
Murfor RND.5/S triangulated  
reinforcement armor, 50 mm wide.

Remate metálico 10 mm de  
espesor soldado al perfil vertical.  
Metal trim 10 mm thick welded to the  
vertical profile.

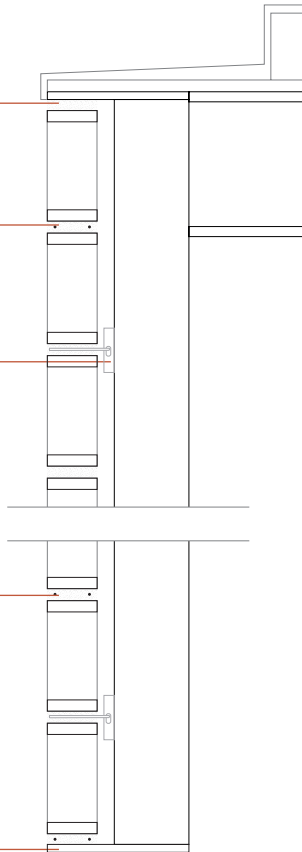

- **Paramento vertical de celosía apoyado en forjado superior e inferior.**  
Supported lattice vertical facing in upper and lower forging.

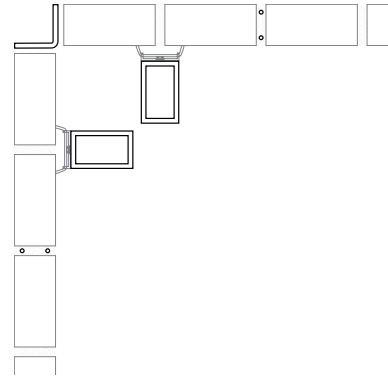

- **Anclajes tipo Murfor MurAnc S 80C.**  
Murfor MurAnc S 80C type anchors.

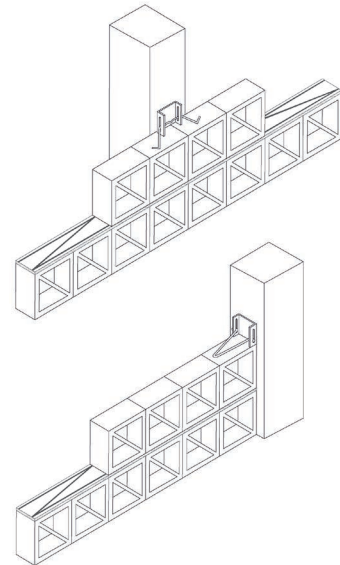

- 
- Paramento vertical apoyado con pieza cerámica colocada en horizontal.  
Vertical facing supported with a ceramic piece placed horizontally.

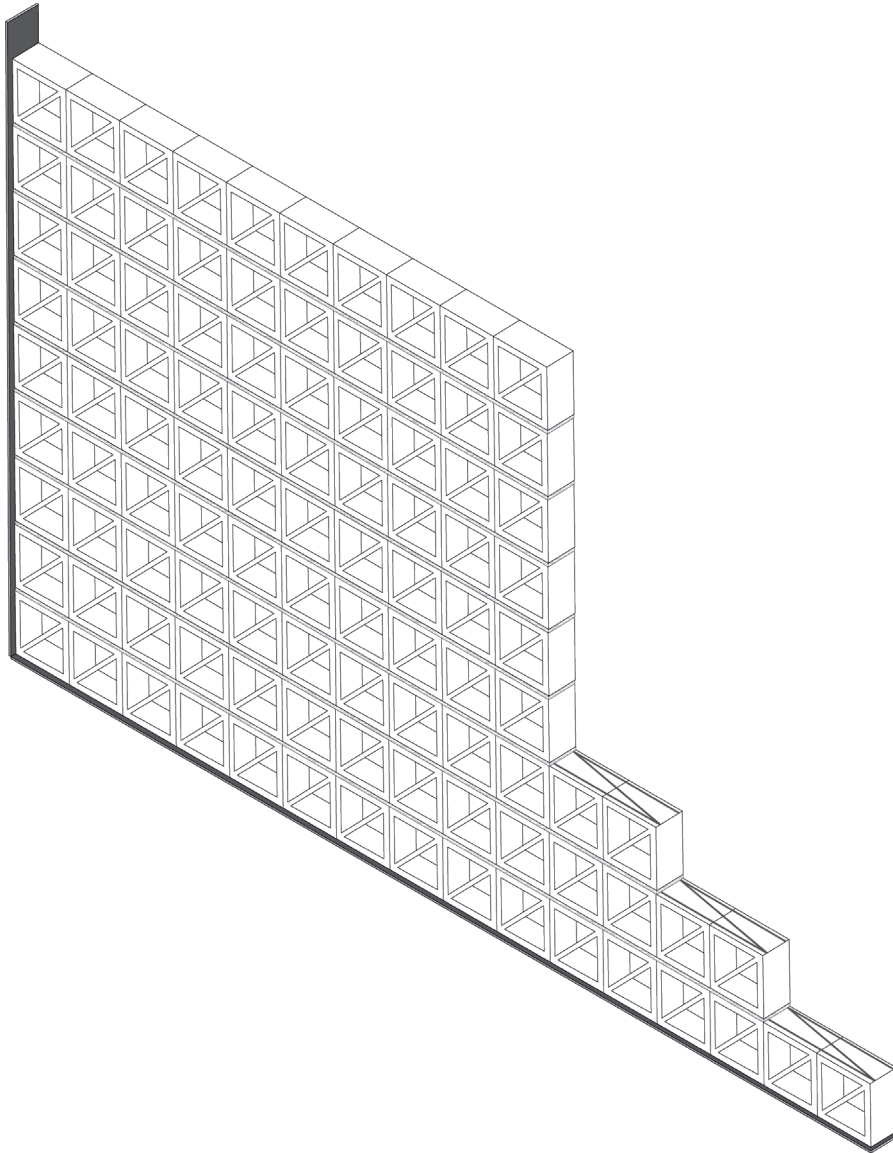

## Consejos de colocación. Placements advices

---

- **Paramento vertical de celosía colgada con subestructura metálica.**  
Vertical hanging lattice facing with metal substructure.

Remate metálico 10 mm espesor.  
Metal trim 10 mm thickness

Redondo de acero inoxidable  
6mm de diámetro.  
Stainless steel round 6 mm diameter.

Anclaje tipo Murfor MurAnc S  
80C cada dos hiladas.  
Murfor MurAnc S 80C type anchor  
every two courses.

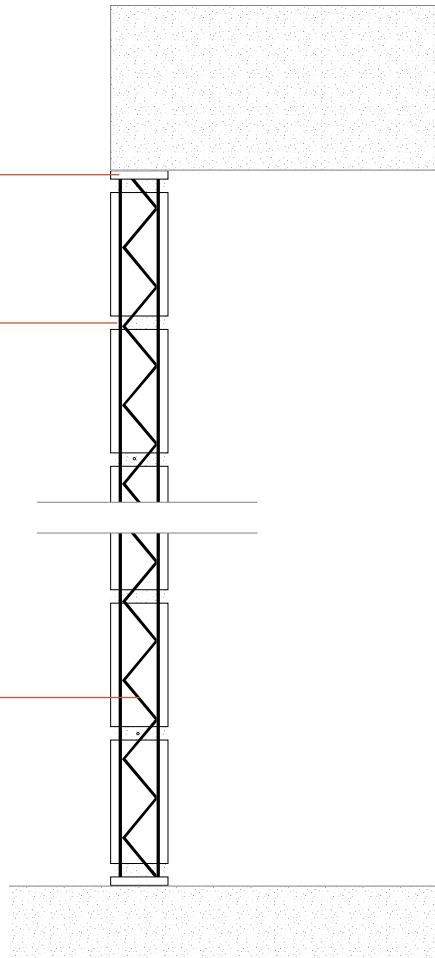

- 
- Sección horizontal de paramento vertical de celosía apoyada con redondo metálico en la junta rehundida.  
Horizontal section of vertical lattice facing supported with metal round in the recessed joint.

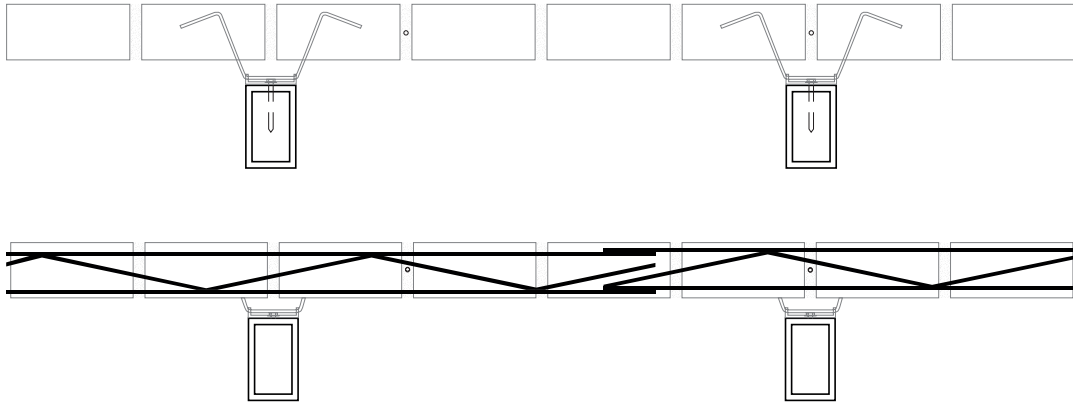

/ 25

- Sección horizontal redondo de acero inoxidable 6 mm de diámetro cada 2 hiladas.  
Round horizontal section of stainless steel 6 mm in diameter every 2 courses.

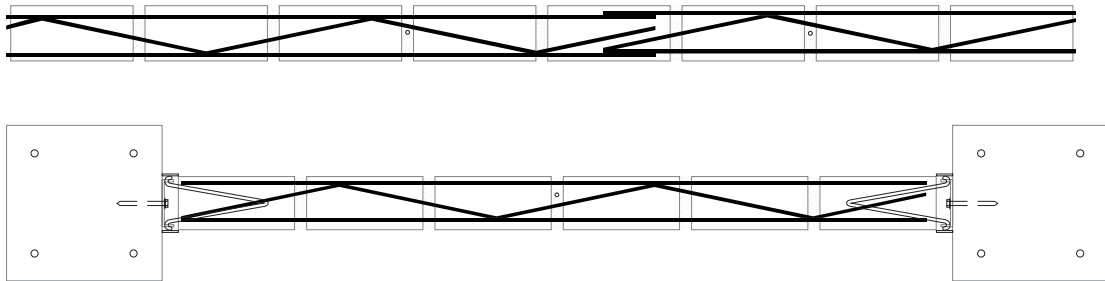

## Características técnicas. Technical characteristics

Gres extruido de baja absorción de agua, esmaltado y no esmaltado  
 Glazed extruded stoneware with a low water absorption glazed and unglazed

NORMA / TEST		DESCRIPCIÓN / DESCRIPTION	RESULTADOS / RESULTS
ISO 10545-3		Absorción de agua Water absorption	0,5 - 3%
ISO 10545-4		Fuerza de rotura Breaking strength	> 6000 N
ISO 10545-8		Dilatación térmica lineal Lineal thermal expansion	4,8x10 <sup>-6</sup> C0-1
ISO 10545-9		Resistencia al choque térmico Resistance to thermal shock	Garantizado Guaranteed
ISO 10545-12		Resistencia a la helada Frost resistance	Garantizado Guaranteed
ISO 10545-13		Resistencia a los agentes químicos Chemical resistance	Clase A

26 /



\*Ejemplos de imperfecciones propias de los productos artesanales, pero esto no altera la calidad de la pieza y en ningún caso serán motivo de reclamación | Examples of imperfections typical of handcrafted products, but this does not alter the quality of the piece and in no case will be cause for complaint.

CELOSIA SYMBOL





cevica®  
the tile atelier

Polígono Pullman, C/ Hungría Nº18 Polígono Pullman,  
12006 Castellón - España  
Tel: +34 964 244 178  
[cevica@cevica.es](mailto:cevica@cevica.es) | [www.cevica.es](http://www.cevica.es)