

# TERRE

COLLECTION

---

Wall tiles | Standard tiles



5x15 cm

cevica®  
the tile atelier





Wall tiles | Standard tiles



/5

cevica.  
the tile atelier

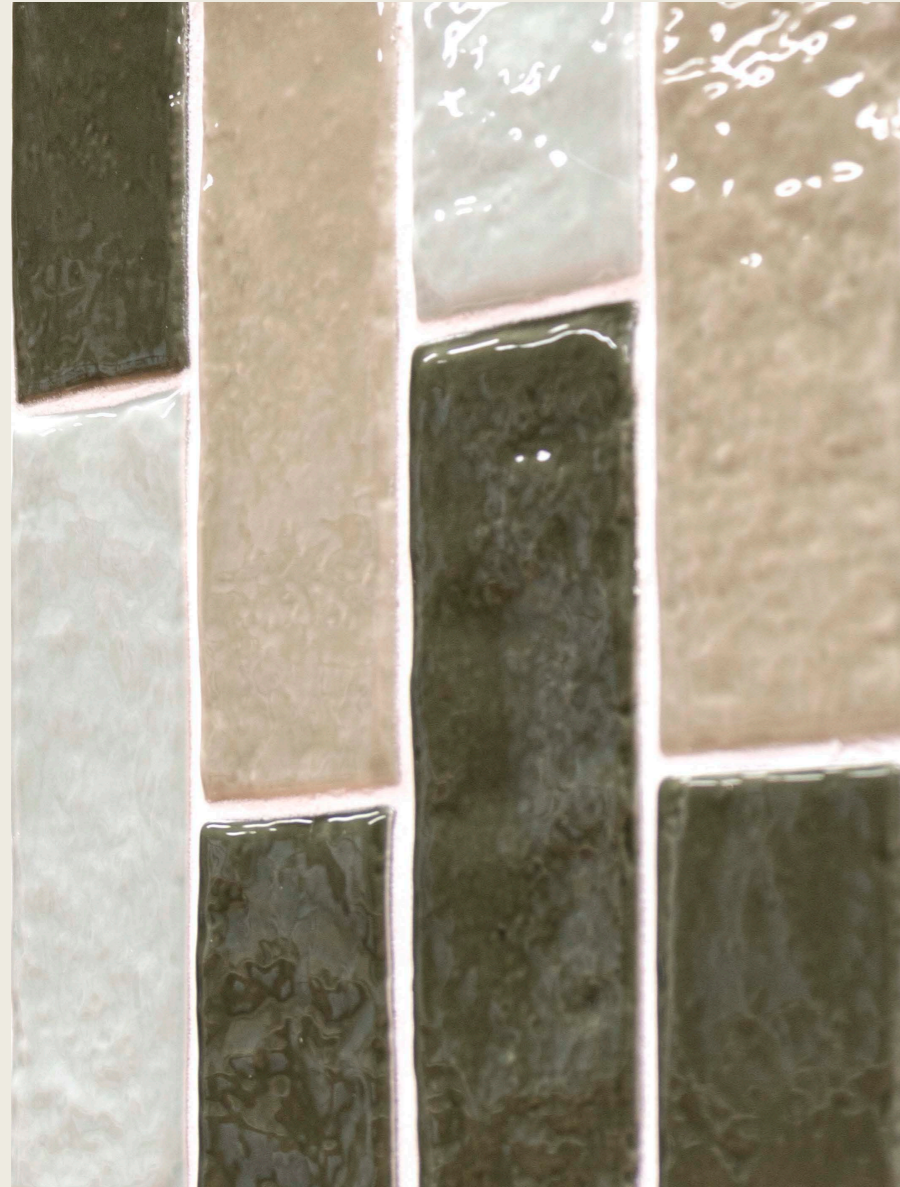

/6

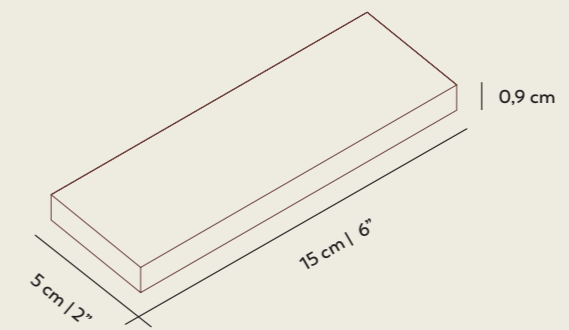

/7

Formada por una rica gama cromática de 18 colores especiales, la colección Terre es fusión del trabajo artesanal y de diseño de nuestro departamento de desarrollo, que ofrece como resultado una colección singular, atractiva, brillante y con un relieve rústico. La riqueza del esmalte de cada uno de los colores y el efecto irregular realiza un efecto muy atractivo que estamos seguros será todo un éxito entre los profesionales de la decoración y el interiorismo.

Made up of a rich chromatic range of 18 special colors, the Terre collection is a fusion of the craftsmanship and design work of our development department, which results in a unique, attractive, bright collection with a rustic relief. The richness of the enamel of each of the colors and the irregular effect creates a very attractive effect that we are sure will be a success among decoration and interior design professionals.



# Terre

collection

Tamaños. Sizes

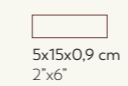

Colores. Colours



Acabados. Finishes



Información técnica. Technical information







12

13



/14

Terre Burgundy



/15

Terre Antic Green

Colores y acabados. Colours & finishes



Terre Superwhite  
LB25

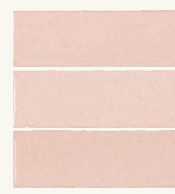

Terre Nude  
LB25



Terre Aqua  
LB25

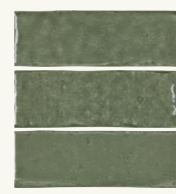

Terre Moss  
LB25



Terre Off White  
LB25



Terre Mint  
LB25



Terre Deep Sea  
LB25

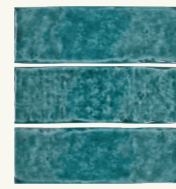

Terre Antic Green\*  
LB66

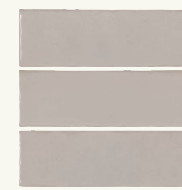

Terre Greige  
LB25

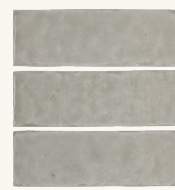

Terre Laurel  
LB25



Terre Sapphire  
LB25



Terre Marine  
LB25

/ 16

Embalaje. Packing

		PZ	KG	M <sup>2</sup>	
base	5x15   2"x6"	60	7,80	0,45	126
quarterround	1,5x15   0,6"x6"	60	2,16		

⚠ \*Atención: Esmalte con alta reacción a los ácidos. Limpiar solo con agua y jabón neutro. Puede cuartear.  
Attention: Glaze with high reaction to acids. Clean only with water and neutral soap. Glaze can crack.



Colores y acabados. Colours & finishes

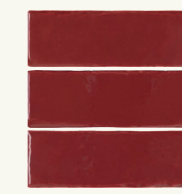

Terre Burgundy  
LB66

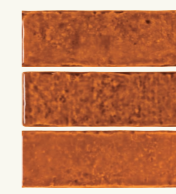

Terre Blood Orange\*  
LB66

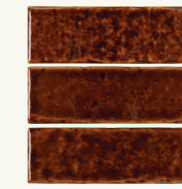

Terre Caramel\*  
LB66

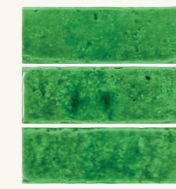

Terre Victorian Green\*  
LB66



Terre Yellow\*  
LB66



Terre Periscope  
LB25

/ 17

Piezas especiales. Special pieces



Quarterround  
1,5x15 cm | 0,6"x6"  
LB48

Disponible en todos los colores / Available in all colours

⚠ \*Atención: Esmalte con alta reacción a los ácidos. Limpiar solo con agua y jabón neutro. Puede cuartear.  
Attention: Glaze with high reaction to acids. Clean only with water and neutral soap. Glaze can crack.





## Características técnicas. Technical characteristics

SERIE	UNE-EN-ISO 10545-3 Absorción de agua Water absorption	UNE-EN-ISO 10545-11 Resistencia al cuarteo Crazing resistance	UNE-EN-ISO 10545-13 Resistencia química Chemical resistance
Terre 5x15	>10%	OK	A
	UNE-EN-ISO 10545-14 Resistencia a las manchas Stain Resistance	UNE-EN-ISO 10545-14 Resistencia a la flexión N/mm2 Bending strenght	UNE-EN-ISO 10545-13 Resistencia choque térmico Chemical resistance
	5	>12 N/mm2	Resist / Resiste
	DESTONIFICADO Shade variation	CONTORNO IRREGULAR Irregular contour	VARIOS MOLDES Several molds
	✓	✓	✓
	JUNTA RECOMENDADA Recommended joint		
	3		



ES



EN



FR



DE

Para más información técnica consultar con el departamento comercial / For more technical information consult with the commercial department.  
 CEVICA se reserva el derecho a anular o modificar el diseño de cualquiera de los modelos que aparecen en este catálogo.  
 CEVICA reserves the right to modify or alter the design in any or all of the models here enclosed.  
 Para información actualizada, visita nuestra web / For updated information, visit our website.



cevica®  
the tile atelier

Polígono Pullman, C/Hungría 18  
12006 Castellón, España  
Tel. +34 964 244 178  
[cevica@cevica.es](mailto:cevica@cevica.es) | [www.cevica.es](http://www.cevica.es)